

OK™ cement mill

The most energy-efficient mill for cement grinding



Quality and profit-improving features

Application advantages

Proven commercially, the OK™ mill is the premier roller mill for finish grinding of Portland cement, slag and blended cements. The mill consistently uses five to ten percent less power than other cement vertical roller mills, and in comparison with traditional ball mill operations, the energy requirements for the OK cement mill is 30-45 percent lower for cement grinding and 40-50 percent lower for slag. The OK mill can contribute significantly to profitability and competitiveness.

The design combines the drying, grinding, material conveying and separation processes into just one unit, thus simplifying the plant layout.

The OK mill incorporates unique patented design elements in the roller and table profile that improve operating stability and reliability, giving a typical availability of 90 to 95 percent of scheduled operating time. Due to its inherent flexibility, the mill can be operated with a number of rollers out of service and still achieve 60 to 70 percent of the nominal output, minimising the risk of lost production due to unplanned stoppages and guaranteed long-term availability. Furthermore, the mill inlet and outlet points can be installed in a specific layout for any plant. Its low noise level makes outdoor installation feasible, substantially reducing civil construction costs and improving the working environment.

Because of its highly effective drying performance, the OK mill is a natural choice for grinding blended cements with one or more wet components.

Design advantages

The OK mill uses a hydro-pneumatic system to press its grinding rollers against the material bed on the rotating grinding table. The patented grooved roller profile has two grinding zones, an inner and an outer. The inner zone prepares the grinding bed by compressing the feed material as it moves under the rollers into the high-pressure grinding zone. The center groove allows air to escape from the material. Grinding pressure is concentrated under the outer zone of the roller, allowing for most efficient operation. Segmented roller wear parts are made of the hardest possible material without risk of cracking and are very well suited for hard facing. Re-positioning of rollers is possible for evening out wear. These features ensure maximum longevity.

Operating advantages

The rollers are in a lifted position when the mill is started, ensuring trouble-free start-up.

Key benefits

■
Energy-
efficiency

■
Easy to
operate

■
High run
factor

■
High
capacity

■
Operating
flexibility

■
Easy
maintenance

■
Low Total Cost
of Operation

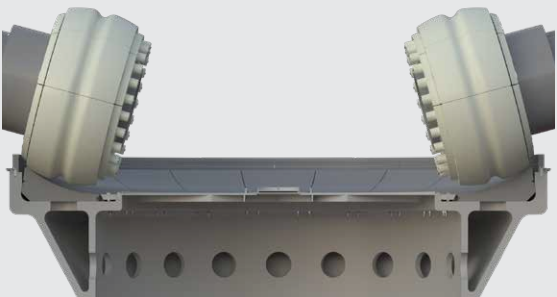
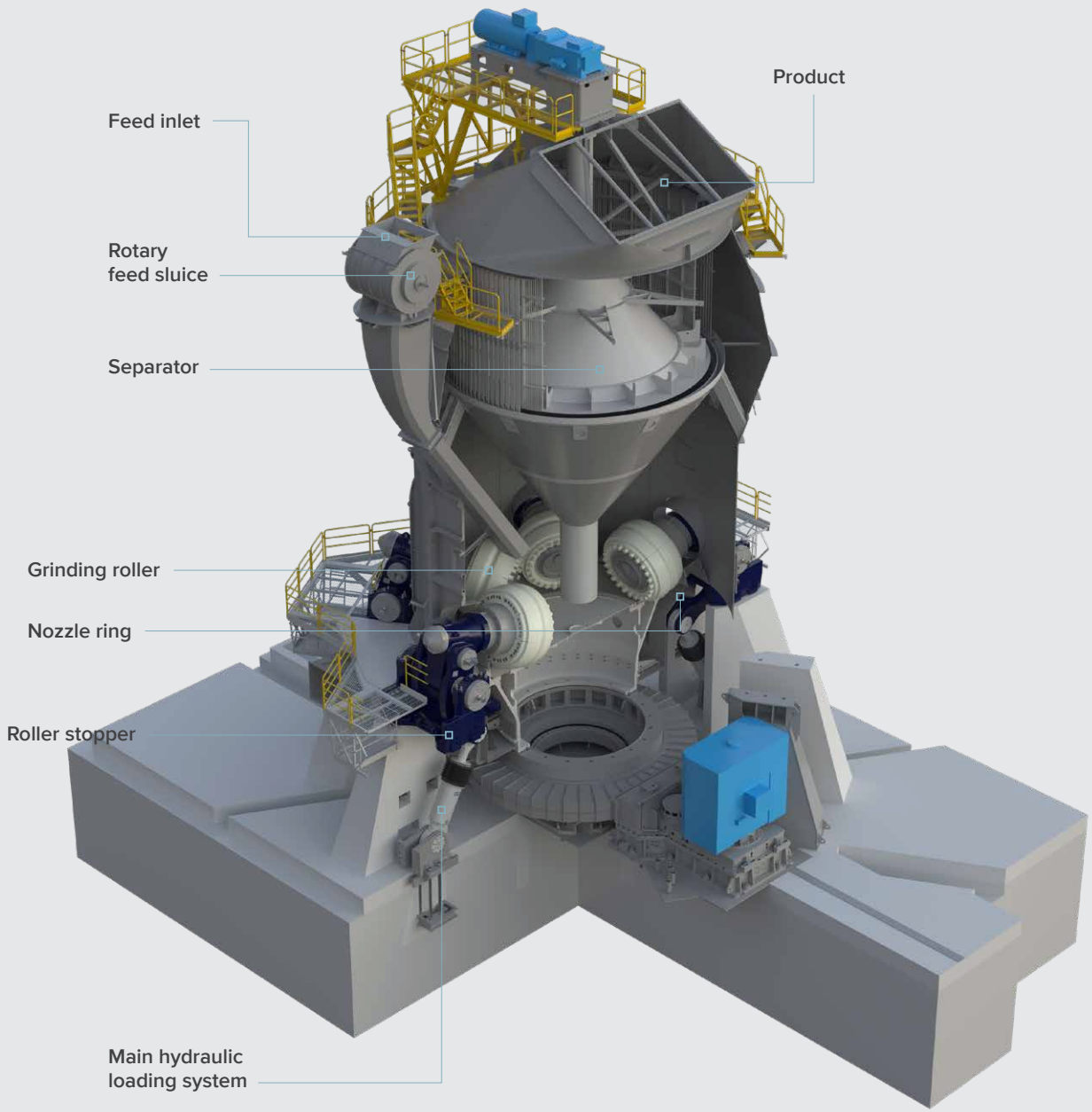

Roller shape & curved table profile



OK 4 roller configuration

Mill design for versatile applications, simple operation and long life

Mill arrangement

This schematic illustrates a typical grinding installation. The arrangement is very simple and the operation is correspondingly flexible and reliable. To maintain the appropriate temperature in the mill circuit – for example to ensure adequate dehydration of the gypsum when grinding cement – the layout is prepared with provisions for recirculation of hot exit gas to the mill inlet. In case the mill feed is wet slag or includes a significant portion of wet additives, additional heat must be provided, for instance from a heat generator. Otherwise, if the mill feed is very hot, the mill exit temperature controls a damper for cold air intake.

One mill, many products

The OK mill efficiently grinds blended cements, with a wide range of additives such as slag, puzzolana, limestone and fly ash. Its versatility is demonstrated by the ability to switch between a wide variety of mixes, and to vary the particle size to meet individual needs.

Particle size distribution

The figure below shows examples of adjustments of particle size distribution when grinding to the same Blaine surface. The required steepness of the particle size distribution curve is attained by adjustment of the separator rotor speed, the mill airflow rate and the grinding pressure, in combination with the appropriate height of the dam ring.

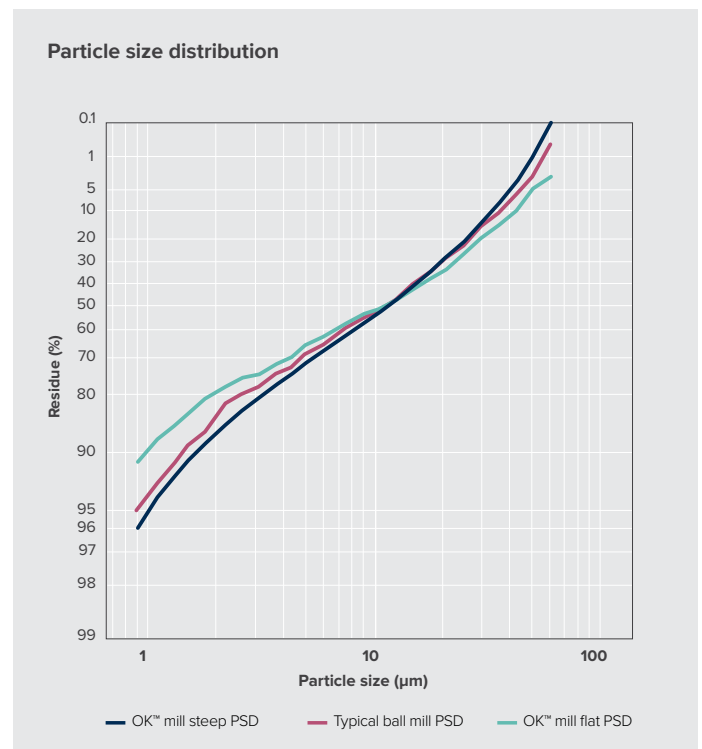
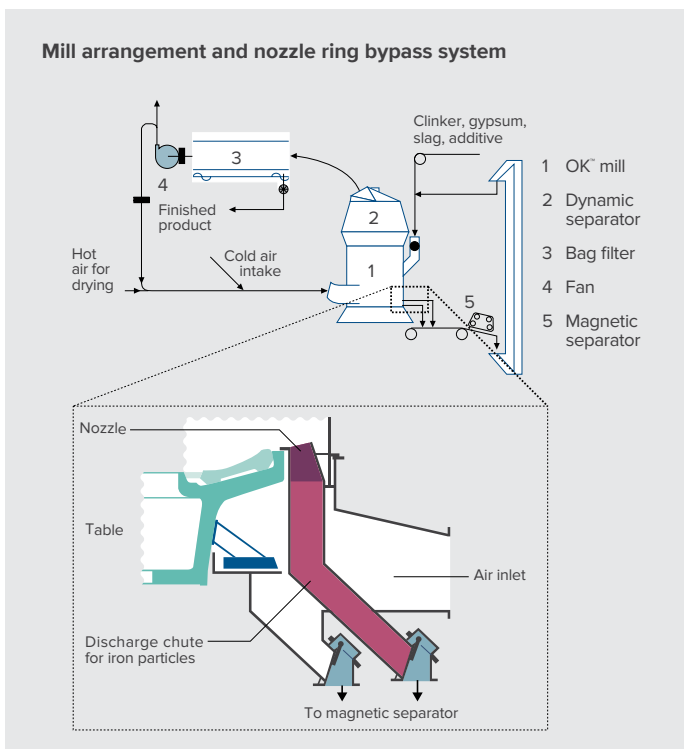

OK™ mill feed composition

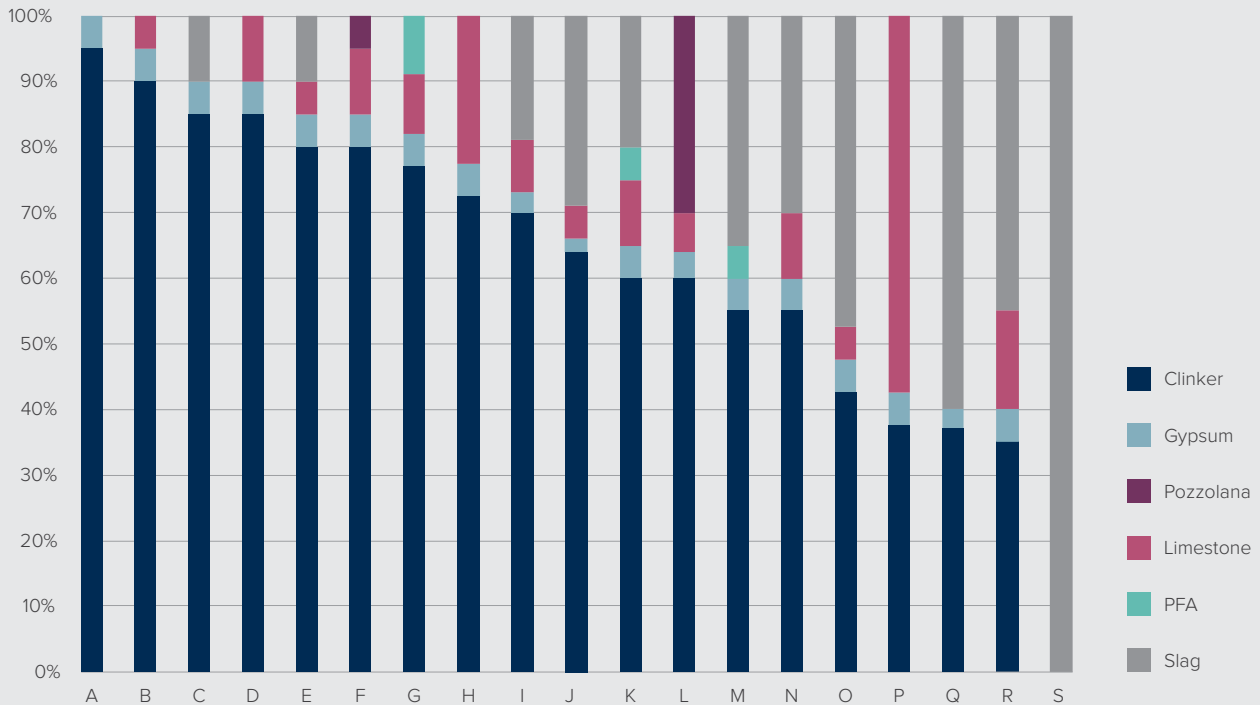

Optimisation of operation

Adjustment of mill airflow and grinding pressure for optimisation of the operation, including adjustment of particle size distribution and switching between different types of products for example from Portland cement to slag cement, can be made immediately. When necessary, adjustment of mechanical components such as the dam ring can be made during short mill stops.

Wear liners

The wear liners of the grinding table and the rollers are of the segmented type and are therefore easy to replace when worn out. For mills grinding very abrasive materials, such as slag, hard-facing is a viable means of achieving a high availability of the grinding system, optimising the grinding process and saving refurbishment costs.

Hard-facing is an economical alternative to changing wear parts and is very suitable for the high chrome cast iron grinding parts used in the OK mill. The segmented type of wear liners can be hard-faced numerous times throughout their life with low risk of cracking due to the welding process.



Hardfaced segments



Flexible seal between housing and roller

Size range

A complete size range ensures the ability to meet all possible capacity requirements in a single mill even for the hardest materials. The OK™ cement mills are available in all sizes.

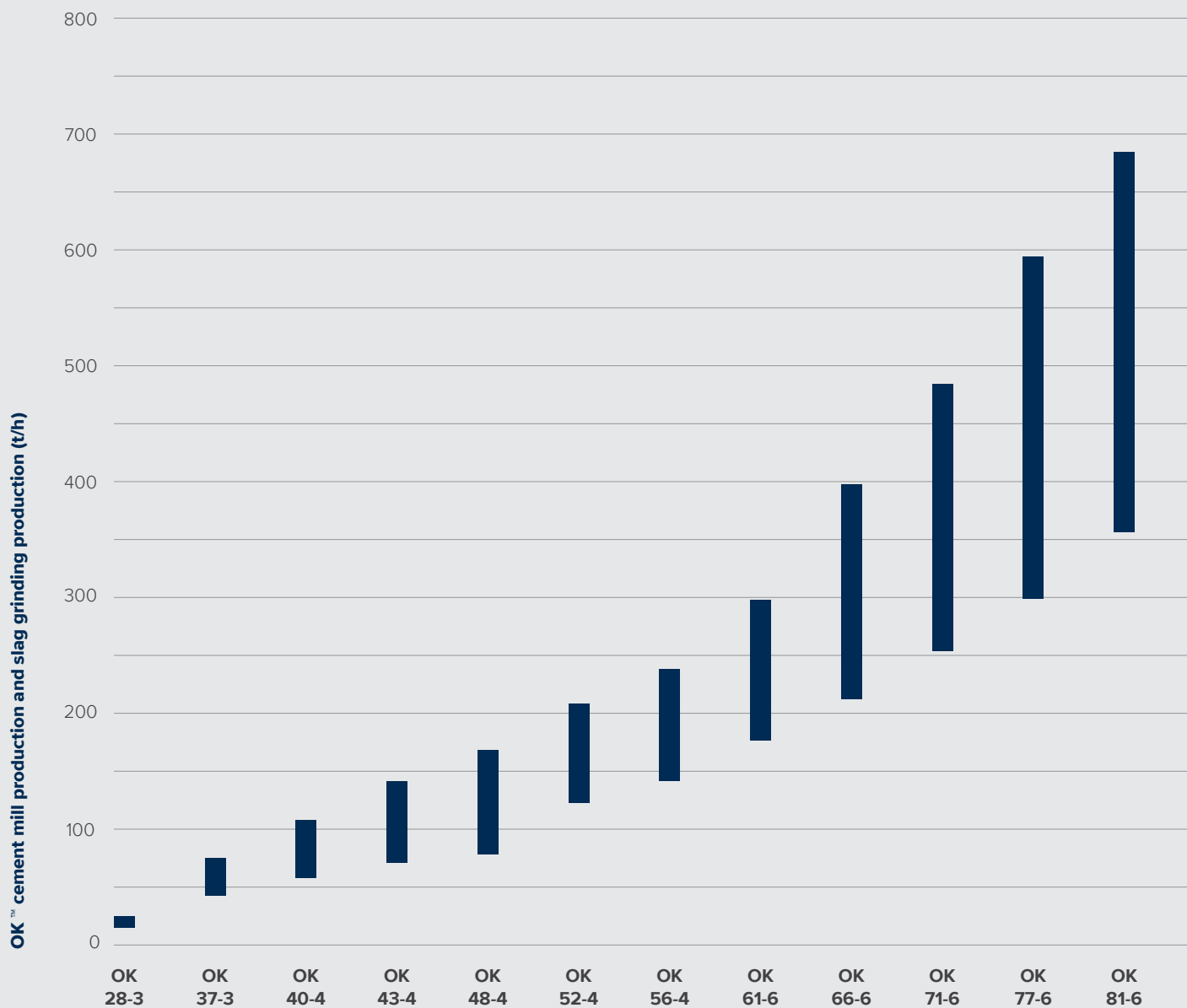

■ OK™ cement mill and slag grinding

Actual capacity depends on product fineness, grindability, and the types and proportion of feed materials

Dimensions and characteristics

Dimensions

| OK™ mill, size | 28-3 | 37-3 | 40-4 | 43-4 | 48-4 | 52-4 | 56-4 | 61-6 | 66-6 | 71-6 | 77-6 | 81-6 |
|-------------------|------|-------|-------|-------|-------|-------|-------|-------|-------|-------|--------|--------|
| A, height | 9,9 | 13,7 | 13,9 | 15,5 | 17,3 | 19,0 | 20,6 | 23,7 | 26 | 30 | 32 | 35 |
| B, width | 5,0 | 8,2 | 7,3 | 7,9 | 8,6 | 9,4 | 10,2 | 10,9 | 11,6 | 12,4 | 13,3 | 14,2 |
| Power, cement, kW | 800 | 1,300 | 1,800 | 2,350 | 3,000 | 3,750 | 4,600 | 5,500 | 6,500 | 7,800 | 9,500 | 11,000 |
| Power, slag, kW | 950 | 1,545 | 2,160 | 2,830 | 3,590 | 4,450 | 5,420 | 6,490 | 7,800 | 9,500 | 11,000 | 13,200 |



Twin mill installation



OK™ mill installation

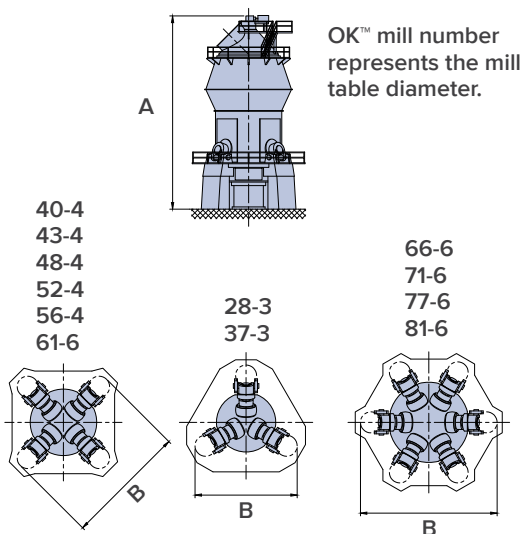

OK™ cement mill

Project Centre Denmark**FLSmidth A/S**

Vigerslev Allé 77
DK-2500 Valby
Copenhagen
Tel: +45 3618 1000
Fax: +45 3630 1820
E-mail: info@flsmidth.com

Project Centre USA**FLSmidth Inc.**

2040 Avenue C
Bethlehem,
PA 18017-2188
Tel: +1 610-264-6011
Fax: +1 610-264-6170
E-mail: info-us@flsmidth.com

Project Centre India**FLSmidth Private Limited****FLSmidth House**

34, Egatoor, Kelambakkam
(Rajiv Gandhi Salai, Chennai)
Tamil Nadu – 603 103
Tel: +91-44-4748 1000
Fax: +91-44-2747 0301
E-mail: indiainfo@flsmidth.com



[flsmidth.com/linkedin](https://www.flsmidth.com/linkedin)



[flsmidth.com/twitter](https://www.flsmidth.com/twitter)



[flsmidth.com/facebook](https://www.flsmidth.com/facebook)



[flsmidth.com/instagram](https://www.flsmidth.com/instagram)



[flsmidth.com/youtube](https://www.flsmidth.com/youtube)